

## 1926-31 Roadster and Phaeton Windshield and Top

### Stock Height, Split Glass Windshield Frame

Steel windshield frame includes inside slugs and frame end glass clips

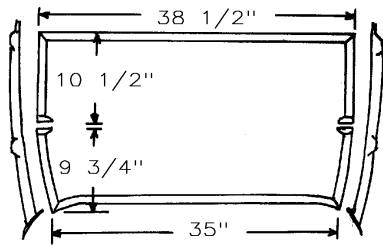

T-37110-EP	Windshield frame, plain	325.00 ea
T-37110-EC	Windshield frame, chrome	600.00 ea

### 4" Chopped Windshield Frame

One piece steel frame, chrome plated. Quality chopped posts are not currently available so cut and weld stock height posts.

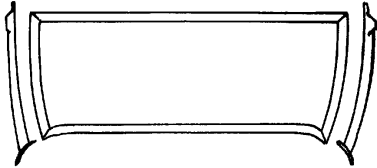

T-37110-EC4	4" Chopped Windshield frame, chrome	600.00 ea
-------------	--	-----------

### Typical 1928-29 Roadster & Phaeton Windshield Components

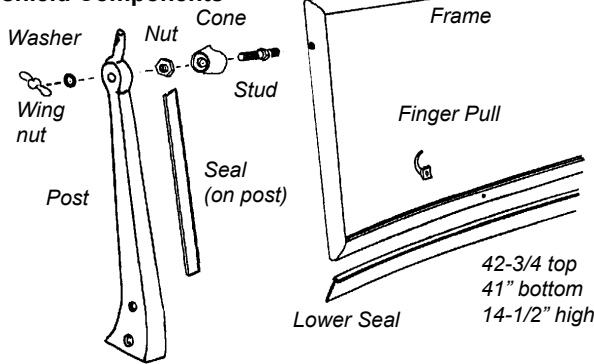

### 1928-29 Windshield Frames

A-37110-AP	Stock height, plain	300.00 ea
A-37110-AC	Stock height, chrome plated	575.00 ea
A-37110-AC2	Chopped 2", chrome plated	750.00 ea

### Typical 1930-31 Roadster & Phaeton Windshield Components

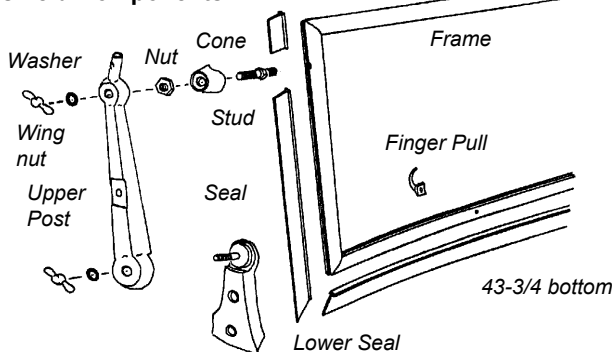

### 1930-31 Windshield Frames

A-37110-BP	Standard, plain 15 1/4" high at side)	300.00 ea
A-37110-BC	Standard, chrome (15 1/4" high at side)	575.00 ea
A-37110-C	Deluxe, chrome (13 3/4" high at side)	575.00 ea
A-37110-C2	Deluxe, chop 2", chrome	750.00 ea

### 1926-27 Windshield Posts

T-37135-DP	Stock height, steel, Black	170.00 pr
T-37135-DC	Stock height steel, Chrome	250.00 pr
T-37135-DP4	Chopped	not.avbl

### 1928-29 Windshield Posts

A-37138-A	Stock height, primed steel	225.00 pr
A-37138-AS	Stock height, stainless	275.00 pr
A-37138-ACS	Chopped 2", stainless	275.00 pr
A-37130-M	Post to body screws, set of 4, chrome	7.50 set

### 1930-31 Upper Windshield Posts:

Polished Stainless Steel.

Available with or without holes for LH or RH mirror or windwings.

Hole Options      Stock Height

Chopped 2"

Std (no mirror no ww)	A-37138-BS	not.avbl	
Dlx LH mirror + ww	A-37138-CS	275.00 pr	B-37138-C      not.avbl
Dlx 2 mirror + ww	A-37138-DS	300.00 pr	B-37138-CD      not.avbl
Dlx no mirror no ww			B-37138-CN      not.avbl
Dlx no mirror + ww			B-37138-CW      not.avbl
Dlx LH mirror no ww			B-37138-CM      150.00 pr

Chopped posts are 1932, require easy modification to lower post.

### 1930-31 Lower Windshield Posts

A-37130-S	Lower posts, fabricated steel, with upper studs	180.00 pr
A-37132-LS	Lower post to dash rail lead spacers	12.50 pr
A-37130-M	Lower post to body screws, set of 4, chrome	7.50 set

### Windshield Hardware



A-351000	Wingnut, chrome plated	5.00 ea
A-351001-SW	Wingnut washer, stainless	1.00 ea
B-37118-S	Finger pulls, chrome	10.00 pr
A-37154-S	Cone, diecast,	7.50 ea
A-37158-S	Stud & cone nut set	5.00 ea

### Windshield frame rubber

T-37199-ES	1926-27 (post sides and bottom of frame)	12.50 ea
A-37199-AS	1928-29 (post sides & frame bottom)	7.50 ea
A-37199-BS	1930-31 (frame sides and bottom)	10.00 ea

### Glass to Frame Setting Tape

B-37193-A	All years, 20 ft, 1/32" thick	10.00 ea
B-37193-B	All years, 20 ft, 3/64" thick	10.00 ea
B-37193-C	All years, 20 ft, 1/16" thick	15.00 ea
B-37193-D	All years, 20 ft, 5/64" thick	15.00 ea

### Windwing Bracket Sets

Windwings act as side air deflectors. They mount to the back side of windshield posts. Quality 1926-27 windwing brackets are not available so we substitute 1930-35 brackets (chrome, set of 4).

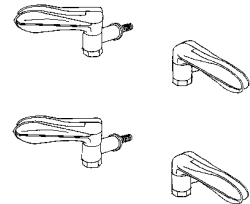

A-18200-B	75.00 set
-----------	-----------

### Roadster & Phaeton Windwing Mirrors

B-17700-WWSS	Any Year, Chromed, clamps to windwing	not.avbl
--------------	---------------------------------------	----------

### Windshield Center Mirrors

#### Black Bracket (26-29 style)

A-17681-A	20.00 ea
-----------	----------

#### Chrome Bracket (30-31 Style)

A-17681-B	30.00 ea
-----------	----------

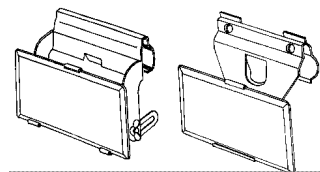

\* Parts with price listed as "not.avbl" are not known to be available at this time, but are listed for reference.

## 1926-31 Roadster and Phaeton Windshield and Top, cont

### Windshield Post Mirrors

A-17700-AR	1928-29	50.00 ea
A-17700-P	1930-31	50.00 ea
Mirror head replacement		
B-17741-MH	flat	22.50 ea
B-17741-MHC	convex	20.00 ea

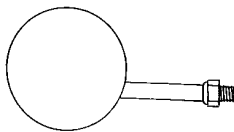

### 1917-29 and 1930-31 Standard Style

#### Tube style Top Irons and Bows

Top iron kits include tapered tube style irons, wood bows, Windshield post thumbscrews, Top mount nuts (plain), and iron to bow hardware.

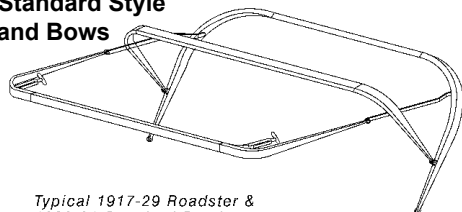

Typical 1917-29 Roadster & 1930-31 Standard Roadster

#### 1917-26 Roadster, Touring and Roadster Pickup

T-41900-AS	1917-22 Roadster (folding)	1000.00 set
T-37800-AS	1917-22 Touring (folding)	1400.00 set
T-41900-BS	1923-25 Roadster & RPU (folding)	1000.00 set
T-37800-BS	1923-25 Touring (foldng)	1400.00 set
T-41900-CS	1926-27 Roadster & RPU (folding)	1000.00 set
T-37800-CS	1926-27 Touring (folding)	1400.00 set

#### 1928-29 Roadster, Phaeton and Roadster Pickup

A-41900-AS	1928-29 Roadster (folding)	1000.00 set
A-77600-AS	1928-29 Roadster Pickup (non-folding)	1000.00 set
A-37800-AS	1928-29 Phaeton (folding)	1400.00 set

#### 1930-31 Standard Roadster, Phaeton and Roadster Pickup

A-41900-BS	1930-31 Standard Roadster (folding)	1000.00 set
A-77600-BS	1930-31 Roadster Pickup (non-folding)	1000.00 set
A-37800-BS	1930-31 Fordor phaeton (folding)	1400.00 set

### 1930-31 Deluxe Roadster

#### Top Irons and Bows

Deluxe style irons use flat bar construction and fold like original.

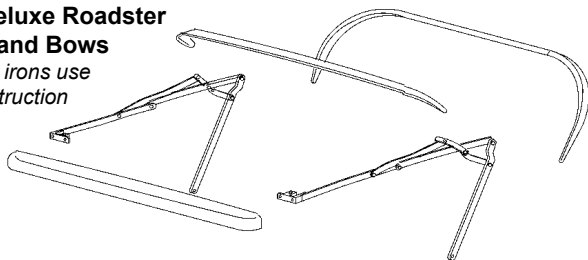

A-42030-PS	Top irons, pln w/stainless arm	1500.00 set
A-42030-PS2	Top irons, chop 2", pln w/stnlrs arm	1500.00 set
A-42030-CS	Top irons, stainless	1500.00 set
A-42030-CS2	Top irons, chop 2"stainless	1500.00 set
A-42055-S	Top wood header & 2 bows	525.00 set
A-180600-S	Rear bow lower chrome mount T bolt	12.50 pr

#### 1930-31 Deluxe (2-Door) Phaeton Top Irons and Bows

Deluxe style irons use a flat bar construction and fold like original.

A-38700-PS	Top irons, pln w/stainless arm	not.avbl
A-38700-PS2	Top irons, chop 2", pln w/stnlrs arm	not.avbl
A-38700-CS	Top irons, stainless	not.avbl
A-38700-CS2	Top irons, chop 2"stainless	not.avbl
A-37455-S	Top wood header & 3 bows	800.00 set

#### Roadster Removable Soft Top: "The Bop Top"

Sid Chavers design soft top features a break down top bow design that allows storing in a space saving soft sided case. Mounts to stock top mounting locations. Fits 2" chop stock style windshield.

#### Specify Black (-B) or Tan (-T)

A-42000-A2x	1928-29 with 2" chop windshield	2750.00 ea
B-42000-2x	1930-31 Deluxe with 2" chop windshield	2750.00 ea

### Top Iron to Windshield Post Thumbscrew

Clamps top irons to windshield posts.

Fine thread, 1917-29, 1930-31 Standard	
A-37472-F	7.50 ea
Coarse thread, 1930-31 Deluxe	
B-37472	7.50 ea

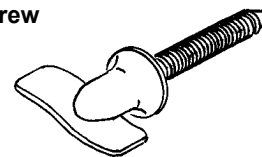

### Top Iron Mounting Parts

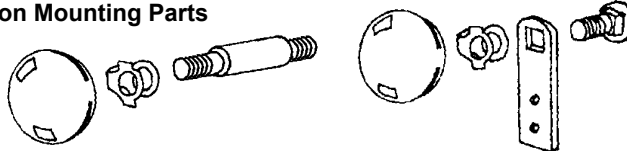

#### Top mount nut and lockwasher, 1926-31 Roadster and Phaeton

B-37708-B	Top mount nut, stainless clad	7.50 ea
B-52550	Top mount nut folding lockwasher	2.50 ea

#### Top mount Stud: 1926-27 Roadster, 1926-31 Touring and Phaeton

A-36636-A	1926-27 Roadster & Touring, 1928-29 Phaeton	25.00 ea
A-36636-B	1930-31 Fordor Phaeton	25.00 ea

#### Top Mount on Quarter Panel 1928-31 Roadster and Roadster PU

B-42027	Bracket, plain	10.00 ea
B-42027-SS	Bracket, polished stainless	40.00 ea
B-42034-P	Bolt, Plain	0.50 ea
B-42034-S	Bolt, Stainless clad	0.75 ea

### Top Rest Saddles

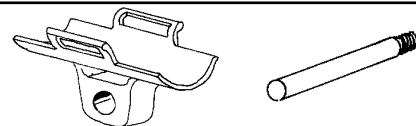

T-3314-BS	Saddles, cast Iron	15.00 ea
T-3858-BS	Studs, 1926-27 Roadster and Touring	12.50 ea
A-37329-A	Studs, 1928-29 Phaeton	25.00 ea
A-37329-B	Studs, 1930-31 Fordor Phaeton	25.00 ea
T-3629-S	Strap and Pad Set, leather	27.50 set

### Roadster Top Tie Down Brackets

Usually called rumble seat grab handles, these are really for resting the top irons on when the top is folded, and to tie it down.

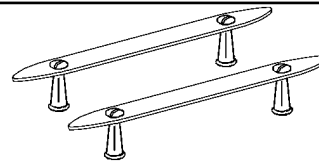

A-41500-SS	45.00 pr
------------	----------

### Side Curtain Rods

Exact reproduction, with flattened top and tapered bottom end.

A-41970-AR	1928-29 Roadster	55.00 pr
A-41970-C	1928-29 Phaeton and Roadster Pickup	55.00 pr
A-41970-B	1930-31 Std Roadster & Std Phaeton	55.00 pr
A-41970-D	1930-31 Deluxe Phaeton	80.00 pr
A-41970	1930-31 Deluxe Roadster	55.00 pr

### Side Curtain Parts

A-41970-B	Snap sockets, 1928-37 (in body)	55.00 pr
A-37103	Studs, 1928-36 (for windshield), set	32.50 set
A-37103	Studs, 1928-36 (for windshield)	32.50 set
A-37102	Studs, 1930-31 (for tack strip)	32.50 set

### Back Window Frames

(glass not included)



#### 1928-31 Roadster, Phaeton, Cabriolet (16 5/8" x 7" od)

A-37639-PL	Stainless outer/tan inner	200.00 ea
A-37639-SS	Stainless outer and inner	250.00 ea

#### Aluminum Mailslot (20" x 4 1/2" od)

H-37639-C	Polished Aluminum	375.00 ea
-----------	-------------------	-----------

## Windshield Wipers

### Hand Wiper,

Chrome, with blade

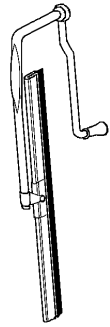

A-17655-AR Any year 25.00 ea

### Wiper Motor: 12 Volt Miniature Replacement

This is the smallest 12v wiper available. This wiper will fit inside header! 100 degree wipe, self park feature. Motor supplied with plastic cover.

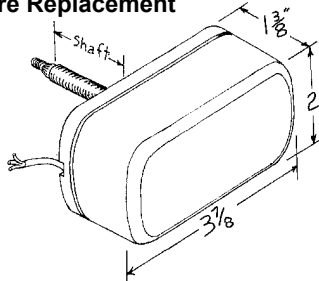

Uses 1937-40 style tapered shaft. Shaft nut included.

#### Motor:

B-17508-A10	1" shaft, 1932-36 Roadster & Phaeton 1926-29 Coupe, Tudor & Pickup	160.00 ea
B-17508-A15	1 1/2" shaft: 1928-31 Roadster & Phaeton 1935-38 Coupes & Sedans, 1935-47 Pickups	160.00 ea
B-17508-A20	2" shaft: 1930-31 Victoria & Slant Windshield 1932-34 Coupes & Sedans, 1938-47 Cabover	160.00 ea
B-17508-A25	2 1/2" shaft: 1930-31 Coupe, Sedan, Pickup (requires hollowing of wood header above windshield)	160.00 ea

### Finned Aluminum Cover for Miniature Motor

Cast aluminum, includes mounting screws, Replaces the plastic cover on the Pacific Western Design mini wiper. Perfect for roadsters and phaetons where the motor is exposed



B-17508-C 125.00 ea

### 12 Volt Universal Replacement Wiper Kits

Motor has stainless steel housing, 110 degree wipe and automatic return. An adjustable (8"-12") wiper arm and an 11" blade are included. The wiper shaft can easily be shortened. This wiper will extend past header area. Has a plain 1/4" shaft.

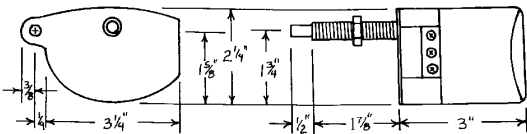

A-17085-SS	12v Universal wiper kit	50.00 ea
SR-17508-SWK	12v Universal wiper w/quick release kit	140.00 ea
U-17529	Arm for universal A-17085-SS motor	17.50 ea
U-17529-CHP	Chopped arm, 6" to 8", for A-17085-SS motor	17.50 ea
U-17528	Blade for universal A-17085-SS motor	5.00 ea

### Replacement Electric Wiper Motor for 1928-36 Arms

Similar dimensions to universal wiper except with switch at back. Arms and blades not included

A-17085-12	12 volt	40.00 ea
A-17085-6	6 volt	45.00 ea

### Roadster "quick release" wiper system

Designed to clamp to the top of the windshield frame for use only when needed. Includes motor, blades, clamps and wire.

SR-17508-SWK 1926-36 140.00 ea

### Specialty Power Windows Wiper Kit

This is the heaviest duty unit available. Universal dual wiper drive has two wiper shafts with a simple to adjust 90 to 160 degree sweep. Towers accept either 1/2" fine knurl end arms (1941-modern), or 1/4" round shaft arm ends. Power is by a high torque late model design wiper motor, using a push-pull cable transmission. For above windshield mounted wipers cable routing is difficult through windshield post so mounting motor behind doors is recommended.

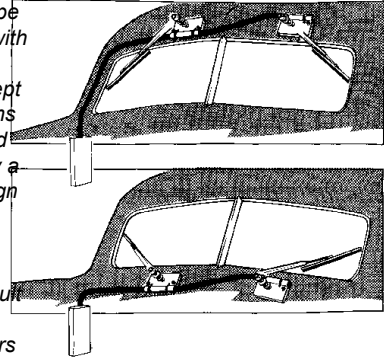

SPW-WWK2I	Wiper Kit for cowl mounting	400.00 ea
SPW-WWKXLWD-2I	Wiper Kit w/long cable for trunk mounting	425.00 ea

### In Header 12v Wiper Kit

Mounts in header, includes transmission, wiper towers, wiper arms and blades

T-17508-2S	1926-27 Coupe & Sedan	450.00 ea
A-17508-A2S	1928-29 Coupe & Sedan	450.00 ea
A-17508-T2S	1928-29 Pickup	450.00 ea
A-17508-2S	1930-31 Coupe & Tudor	425.00 ea
B-17508-T2S	1932-34 Pickup	450.00 ea
48-17508-2S	1935-36 Coupe & Sedan	450.00 ea
50-17508-2S	1935-36 Pickup	450.00 ea
78-17508-C2S	1937 Coupe & Sedan	450.00 ea
81A-17508-C2S	1938 Coupe & Sedan	450.00 ea
01C-17508-2S	1940-47 Pickup	450.00 ea

### Direct Replacement 12 volt Wiper Motors

Replaces original vacuum wiper and uses original transmission and towers.

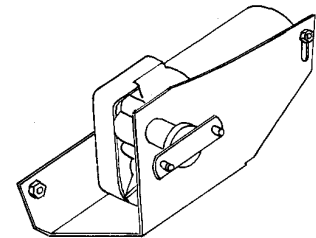

78-17508-2S	1937-39 Convertible & Wagon (stock under dash location)	250.00 ea
91A-17508-2S	1939 Coupe & Sedan	250.00 ea
01A-17508-2S	1940 Passenger (firewall mount)	250.00 ea
11A-17508-2S	1941 Coupe, Sedan & Convertible	250.00 ea
21A-17508-2S	1942-47 Coupe, Sedan & Convertible	250.00 ea
6A-17508-2S	1948 Coupe, Sedan & Convertible	250.00 ea
7C-17508-2S	1948-50 Pickup	250.00 ea
1C-17508-2S	1951-52 Pickup (replaces vacuum motor)	250.00 ea
1C-17508-E2S	1951-52 Pickup (replaces original electric motor)	275.00 ea
BAAA-17508-2S	1953-55 Pickup (replaces vacuum motor)	250.00 ea
BAAA-17508-E2S	1953-55 Pickup (replaces original electric motor)	275.00 ea
B6C-17508-2S	1956-60 Pickup (replaces vacuum motor)	250.00 ea
B6C-17508-E2S	1956-60 Pickup (replaces original electric motor)	275.00 ea

### Wiper Motor to Linkage Spring Clip

78-17540	1937-40 Convertible/Wagon, 1940 Passenger	5.00 ea
06H-17531	1941-48 Passenger, 1948-56 Pickup	2.00 ea

\* Parts with price listed as "not.avbl" are not known to be available at this time, but are listed for reference.

## Windshield Wipers, cont

### Wiper Tube (or Wiring) to Cowl Grommet

B-17523	1932-36 Roadster & Phaeton	7.50 ea
---------	----------------------------	---------

### Wiper motor to windshield frame clamp

1926-31 Roadster & Phaeton

A-17589-S	fits original vacuum motor use spacers with mini wiper	10.00 set
-----------	---	-----------

### Wiper Motor Shaft to Roof Seals & Bezels

40-17515	1933-34 Coupe & Sedan: Bezel, chrome	not.avbl
40-17541	1933-34 Coupe & Sedan: Seal, rubber	3.00 ea
48-17515	1935-36 Coupe, Sedan & PU: Bezel, chrome	not.avbl
48-17541	1935-36 Coupe, Sedan & PU: Seal, rubber	5.00 ea
78-17515	1937-39 Coupe, Sedan & PU: Bezel, chrome	12.50 ea
11A-17541	1937-39 Coupe, Sedan & PU: Seals, rubber	3.00 pr

### Wiper Motor Shaft to Cowl Seals and Bezels

01C-17515	1940-47 Pickup: Bezel, chrome	not.avbl
11A-17541	1940-47 Pickup: Seal, rubber	3.00 pr
11A-17515	1941-48 Passenger: Bezel, chrome	22.50 pr
11A-17541	1941-48 Passenger: Seal	3.00 pr
7C-17515	1948-52 PU: Bezel, chrome, RH or LH	10.00 ea
7C-17515-NUT	1948-52 PU : Nut (hex), chrome, RH or LH	7.50 ea
7C-17541	1948-52 PU: Seal, 1948-52	3.00 pr
BAAA-17515	1953-56 PU: Bezel, chrome, RH or LH	7.50 ea
7C-17515-NUT	1953-55 PU: Nut (hex), chrome, RH or LH	7.50 ea
B6C-17515-NUT	1956 PU: Nut (slotted), chrome, RH or LH	7.50 ea
BAAA-17541	1953-56 PU: Seal, 1953-56	3.00 pr

### Windshield Wiper Towers on Body

Includes both towers and linkage to motor

1940 Convertible/Wagon towers and linkage can be used on 1937-39 Convertible/Wagon by using a 1940 style firewall mount motor.

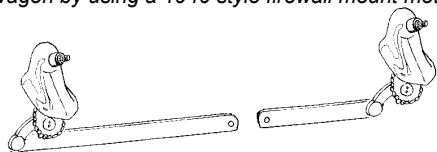

78-17552-S	Wiper Towers: 1937-39 Convertible/Wagon	120.00 set
01A-17552-CS	Wiper Towers: 1940 Convertible/Wagon	175.00 set
01A-17552-DS	Wiper Towers: 1940 Coupe & Sedan	120.00 set
78-17556	Pads: 1937-40 Convertible	5.00 pr
01A-17556	Pads: 1940 Coupe & Sedan	5.00 pr

### 1948-56 Pickup Wiper Pivot

7C-17566-A	RH, 1951-52 Pickup	35.00 ea
7C-17567-A	LH, 1951-52 Pickup	35.00 ea
BAAA-17566	RH or LH, 1953-55 Pickup	30.00 ea
B6C-17566	RH or LH, 1956 Pickup	30.00 ea

### Wiper Arms and Blade for 1928-36 Wiper Shaft

Fits the 1928-36 shaft with the groove and pin hole.

Note that most cars and pickup with visor used an external mount wiper motor.

#### Wiper Arms

A-17529	for external mount vacuum motor	5.00 ea
B-17529	for internal mounted motors	10.00 ea

#### Wiper Blade

A-17528	Wiper blade, 7 1/4"	5.00 ea
68-17528	Wiper blade, 8 1/4"	5.00 ea
11A-17528	Wiper blade, 9"	5.00 ea



### Wiper Arms and Blades for 1937-40 Taper shaft

1937-40 Style arms and blades fit original vacuum wipers or 12v miniature replacement motors.

Original Ford used the hook style. Hook style blades can be easily shortened. Hook style arms can be shortened with modest effort.

Wrist style arms and blades are the 1950's style attachment and are not easily shortened.

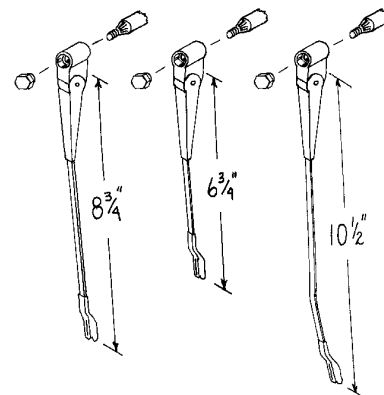

"Hook Style"		"Wrist Style"		
Wiper Arm 6 3/4"	01A-17529	17.50 ea	01A-17529-WT	17.50 ea
Wiper Arm, 8 3/4"	78-17529	17.50 ea	78-17529-WT	17.50 ea
Wiper Arm, 10 1/2" LH	01C-17526-LH	17.50 ea	01C-17527-WT	17.50 ea
Wiper Arm, 10 1/2" RH	01C-17526-RH	17.50 ea	01C-17526-WT	17.50 ea
Wiper Blade, 6"	A-17528	5.00 ea	SR-17528	15.00 ea
Wiper Blade, 8"	68-17528	5.00 ea	78-17528-WT	15.00 ea
Wiper Blade, 9"	11A-17528	5.00 ea		
Wiper Arm Shaft Nut	78-17481	7.50 ea		

### 1/2 Spline Shaft Adaptor

1/2" Spline shaft end to mount to 1928-36 groove & pin style, 1/4" smooth, and 1937-40 taper shaft (nut not included)

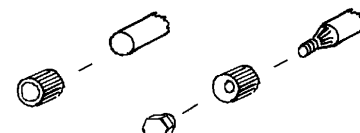

11A-17500-2836	fits 1928-36 groove & pin, or 1/4" shaft	10.00 ea
11A-17500-3740	fits 1937-40 taper shaft	10.00 ea

### Wiper Arms and Blades

Fit 1941-Modern 1/2" Spline shaft

"Hook" blade/arm connection style were original through 1948. Hook style blades can easily be shortened. Wrist style was typical 1949-1950's. A more effective wiper design yet difficult to modify length

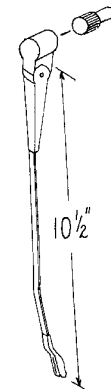

	Hook Style	Wrist Style.	
6" blade		SR-17528	15.00 ea
7 1/2" blade	A-17528		5.00 ea
8 1/4" blade	68-17528		5.00 ea
9" blade (41-48)	11A-17528		5.00 ea
10" blade (48-52 PU)		7C-17528	15.00 ea
11" blade		8A-17528	17.50 ea
12" blade (53-56 PU)		B6C-17528	15.00 ea
Arm RH 41-48 10 1/2"	11A-17529-R		17.50 ea
Arm LH 41-48 10 1/2"	11A-17529-L		17.50 ea
Arm, 48-52 PU	7C-17527		17.50 ea
Arm, 53-55 PU	B6C-17527		17.50 ea
Arm, 56 PU LH	B6C-17527		17.50 ea
Arm, 56 PU RH	B6C-17526		17.50 ea
		11A-17529-RW	17.50 ea
		11A-17529-LW	17.50 ea

\* Parts with price listed as "not.avbl" are not known to be available at this time, but are listed for reference.