

Universal Window Felt Parts

Door Window Felt Strips, Universal, 8' Strips

Single Sided Strips:

	17/64	15/64	1/4	21/64	
	7/16	7/16	9/16	9/16	
	1	2	3	4	
H-45983-1	Single side strip, black bead			25.00 ea	
H-45983-2	Single side strip, stainless bead			22.50 ea	
H-45983-3	Single side strip, black bead			30.00 ea	
H-45983-4	Single side strip, stainless bead			30.00 ea	

U Shape, no bead:

	1/4	3/16 - 1/4	3/16 - 1/4	7/16 - 1/2	3/16 - 1/4	
	9/16	1/2	17/32	5/8	3/8	
	5	6	7	9	10	
	5/8	5/8	5/8	27/32	1/2	
H-45983-5	U shape, flexible, felt lined, black					40.00 ea
H-45983-6	U shape, flexible, felt & pile lined, black					40.00 ea
H-45983-7	U shape, flexible, pile lined, black					35.00 ea
H-45983-9	U shape, flex, pile line, 7/16 to 1/2 glass (72" length)					45.00 ea
H-45983-10	U shape, rigid, felt & pile lined, black					30.00 ea

U Shape, Stainless bead

		3/16 - 1/4	3/16 - 1/4	
<i>U shape, flex, felt & pile lined</i>				
H-45983-8	40.00 ea	9/16	1/2	12
<i>U shape, rigid, pile lined</i>		5/8	1/2	
H-45983-12	45.00 ea			

Double Channel, U shape

<i>used on some station wagon sliding windows</i>		7/16 - 1/2	
<i>Pile & felt lined</i>		1/2	1 - 7/64
H-45983-20	50.00 ea		

Window Felt Mounting Hardware

These clips are included in complete window felt kits.

YB-16740-C	Clip for ends of felt	1.00 ea
B-703536	Small headed screws, black, used to mount fuzzy strips to window openings when original hardware is not used (25 pcs)	5.00 set
48-703536-A	Punch Clips used 1935-52 (25 pcs)	10.00 ea
48-703536-B	Garnish Clips used 1935-36 (25 pcs)	10.00 ea
78-703536	Staples used 1937-48 (25 pcs)	5.00 ea
11A-703536	V Clips used 1941-48 (25 pcs)	10.00 ea

Window Felt Universal Guide Channel

U shape, use to support 5/8 wide felt for custom applications.
36" length:

H-45983-WC	30.00 ea
------------	----------



Window Glass to Frame Setting Tape

B-37193-A	All years, 20 ft, 1/32" thick	10.00 ea
B-37193-B	All years, 20 ft, 3/64" thick	10.00 ea
B-37193-C	All years, 20 ft, 1/16" thick	15.00 ea
B-37193-D	All years, 20 ft, 5/64" thick	15.00 ea

1932-35 Window Glass Anti-Rattlers

Fits into holes in door, body, and garnish molding. Included in felt kits.

B-46044	Door or body	0.75 ea
B-45830	Garnish molding	0.75 ea

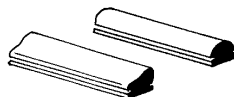

Window Glass Bottom Rest Bumper

Included in felt kits.

B-48141	1926-34	1.00 ea
---------	---------	---------

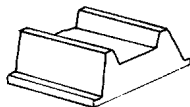

Power Window Regulators

"Geared" Power Window Kits by Specialty Power Windows

This kit features AC Delco motors and includes regulators, window glass bottom channels, necessary mounting brackets, control switches, and switch wire harnesses. Minimum 24" glass width.

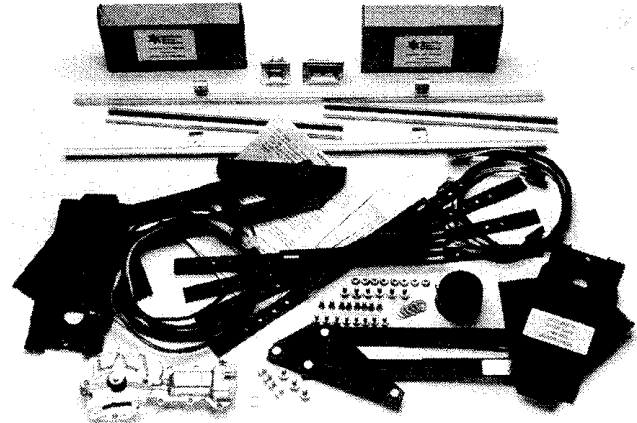

SPW-48100-A	2-Window, for Coupe, Convrt*, Pickup	500.00 set
SPW-48100-C	4-Window, for Sedan	950.00 set
	<i>*Convertibles may need fabrication of upper stops for proper glass top control.</i>	

Geared Regulator Kit for Model A

Specially designed for easy installation into 1928-31 Model A. These are single arm regulators. Kit includes wiring and switches.

SPW-48100-MA	2-Window, for Coupe & Pickup	500.00 ea
SPW-48100-MC	4-Window, for Sedan	950.00 ea

Wonder Lift Regulator Kits by Specialty Power Windows

This kit features Bosch motors and includes regulators, window glass bottom channels, necessary mounting brackets, control switches, and switch wire harnesses.

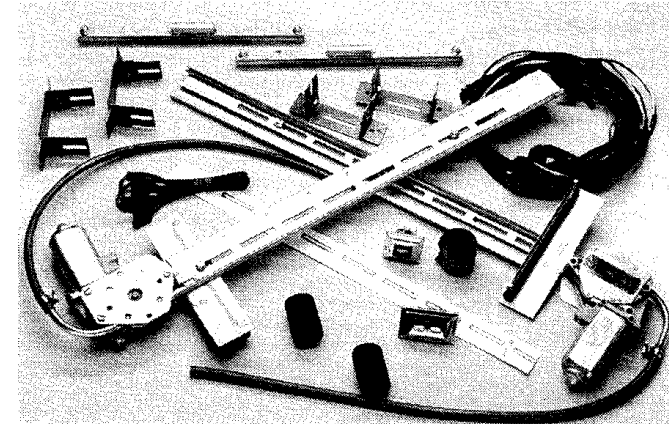

SPW-48100-LA	2-Window, for Coupe & Pickup	500.00 set
SPW-48100-LC	4-Window, for Sedan	950.00 set

Back Window Power Window Unit

We designed it for our 1932 3-Window Coupe, Specialty Power Windows makes it. Requires fabrication of a new mounting base plate to use on steel cars. Other fiberglass cars may need extra modifications to mount base plate and mount window channels.

SPW-48100-RW	Back Window Power Unit	350.00 ea
--------------	------------------------	-----------

* Parts with price listed as "not.avbl" are not known to be available at this time, but are listed for reference.

1926-31 Window Parts

Door Garnish Moldings,

**1926-27 Coupe & Tudor Sedan,
1928-29 Pickup**

Stamped Steel

Door lower, finger pull		
A-80033-S		125.00 pr
Door upper frame		
1928-29 Pickup Style		
A-80025	RH	95.00 ea
A-80026	LH	95.00 ea

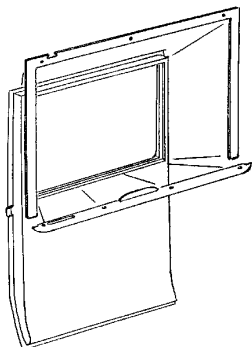

**1926-27 Coupe
Quarter Window
Garnish Moldings**

*Fiberglass with return flange
against door edge, not a raw edge*

CG2627QR	RH	200.00 ea
CG2627QL	LH	200.00 ea



**1926-27 Tudor Sedan
Quarter Window
Garnish Moldings**

Upper
T-56051-UQ not.avbl

Lower
(1928-31: Trim to fit 1926-27)
A-56050-Q 125.00 pr

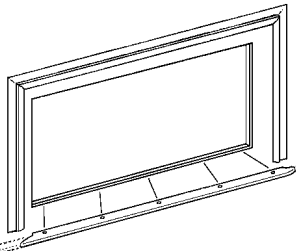

**1926-27 Coupe & Tudor Back
Window Garnish Molding**

*Fiberglass with return flange
against door edge, not a raw edge.*
RWM2627CS 200.00 ea



**Door & Door Opening Garnish Moldings
1928-31 Coupe & Tudor Sedan & 1930-31 Pickup**

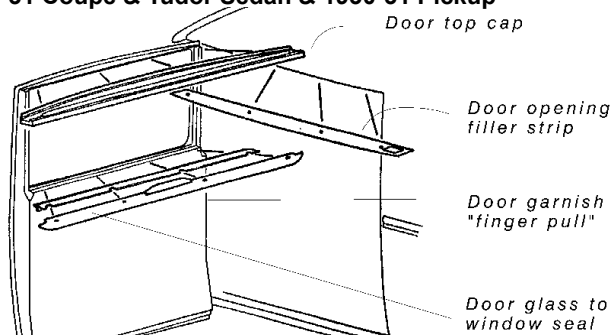

Door "finger pull" garnish moldings:		
A-46050-AS	1928-29 Coupe & Tudor	125.00 pr
A-46050-DS	1930-31 Coupe	125.00 pr
A-46050-CS	1930-31 Tudor & Pickup	125.00 pr
Door top cap:		
A-45883-A	1928-31 Tudor, 1928-29 Coupe, 1930-31 PU	90.00 ea
A-45883-B	1930-31 Coupe	90.00 ea
Door opening filler strips:		
A-45891-AS	1928-31 Tudor, 1928-29 Coupe, 1930-31 PU	32.50 pr
A-45891-BS	1930-31 Coupe	32.50 pr

1928-31 Window Garnish Seals & Brackets

Mounts under garnish molding, seals against glass.

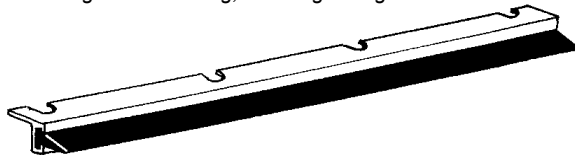

A-19008-A	1928-29 Coupe, 1930-31 Pickup	15.00 pr
	1928-31 Tudor sedan (doors)	
A-19008-B	1930-31 Coupe	15.00 pr
A-19008-C	1928-31 Tudor sedan (quarter windows)	15.00 pr
A-19008-4DF	1928-30 Fordor (front door) and Cabriolet	15.00 ea
A-19008-4DR	1928-30 Fordor (rear doors)	15.00 ea

1928-31 Coupe, Tudor, 30-31 PU Door Garnish Screws

Note: Included in interior trim screw kits when needed.

A-342-S	Door garnish screws	1.50 ea
A-45883-MB	Door top cover screw set	1.50 ea
A-45890-MB	Door opening header screw set	1.50 ea

1928-31 Coupe Quarter Window Garnish Moldings, Fiberglass



CG2829Q	1928-29 Coupe, RH or LH	100.00 ea
CG3031RQ	1930-31 Coupe, RH	100.00 ea
CG3031LQ	1930-31 Coupe, LH	100.00 ea

1928-31 Tudor Sedan Quarter Window Garnish Moldings

Upper
A-56051-UQ not.avbl

Lower
A-56050-Q 125.00 pr

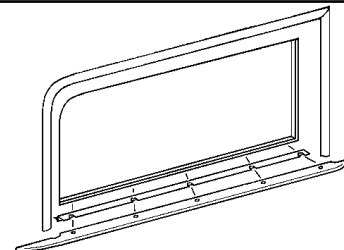

Finger Pulls on Garnish, Chrome Plated

A-61062-CR	1928-30 Cabriolet & Fordor sedan	12.50 ea
------------	----------------------------------	----------

1928-31 Coupe & Tudor Back Window Garnish Molding

Fiberglass
**1928-31 Coupe, Tudor
some Fordor Sedans**
RWM2831CS 125.00 ea



1928-31 Pickup Back Window Garnish Moldings



A-83820-AR	1928-29 Pickup, stamped steel	32.50 ea
A-83820-B	1930-31 Pickup, stamped steel	95.00 ea
RWM3034PU	1930-31 Pickup, fiberglass	125.00 ea

* Parts with price listed as "not.avbl" are not known to be available at this time, but are listed for reference.

1926-31 Window Parts, cont

1930-31 Victoria Door Header Panels

The panels on the body above door.

	RH		LH	
Cloth back victorias	A-45891-VCR	275.00 ea	A-45891-VCL	275.00 ea
Steel back victorias	A-45891-VSR	130.00 ea	A-45891-VSL	130.00 ea

1930-31 Victoria Window Garnish Moldings

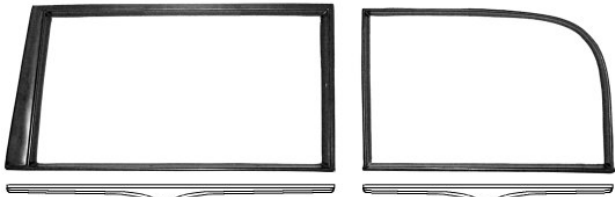

	RH		LH	
Door window, 'glas	CG3031VDR	not.avbl	CG3031VDL	not.avbl
Door lower trim, steel	A-542-BVR	180.00 ea	A-542-BVL	180.00 ea
Quarter window, 'glas	CG3031VQR	not.avbl	CG3031VQL	not.avbl
Quarter trim, steel	A-542-BVQ	155.00 ea	A-542-BVQ	155.00 ea
RWM3031V	Back window frame, fiberglass			not.avbl

1931 Fordor Sedan Door Window Garnish Lower Trim

A-542-BFD	1931 Fordor ft door: RH or LH	155.00 ea
A-542-BRD	1931 Fordor rear door: RH or LH	155.00 ea
A-542-BQ	1931 Fordor quarter: RH or LH	140.00 ea

Door Window Garnish Molding Tube Nut Sets

Note: Included in interior trim screw kits when needed.

AH-1102	8-32, set of 10, 1931 Slant Windshield	7.50 set
AH-1103	6-32, set of 6, 1928-30 Briggs Fordor	5.00 set

1928-29 Interior Trim Screw Sets

AH-280	1928-29 Briggs 4D w/o qtr window	25.00 set
AH-281	1928-29 Briggs 4D w/qtr window	25.00 set
AH-282	1928-29 Murray Fordor sedan	20.00 set
AH-283	1928-29 Roadster	10.00 set
AH-284	1928-29 Roadster pickup cab	10.00 set
AH-285	1928-29 Sport coupe	10.00 set
AH-286	1928-29 Standard coupe	10.00 set
AH-287	1928-29 Tudor sedan	12.50 set
AH-288	1928-29 Closed pickup cab	12.50 set
AH-289	1928-29 Cabriolet	17.50 set
AH-290	1928-29 Phaeton	10.00 set

1930-31 Interior Trim Screw Sets

AH-300	1930-31 Briggs Fordor sedan	27.50 ea
AH-301	1930-31 Murray Fordor sedan	22.50 ea
AH-302	1930-31 Slant windshield, Fordor	35.00 ea
AH-303	1930-31 Roadster	10.00 ea
AH-304	1930-31 Roadster pickup cab	7.50 ea
AH-305	1930-31 Standard (Fordor) phaeton	10.00 ea
AH-306	1930-31 Deluxe (Tudor) phaeton	10.00 ea
AH-307	1930-31 Sport coupe	10.00 ea
AH-308	1930-31 Standard coupe	10.00 ea
AH-309	1930-31 Tudor sedan	12.50 ea
AH-310	1931 Slant windshield, Cabriolet	17.50 ea
AH-311	1930-31 Victoria	20.00 ea
AH-312	1931 A-400 Convertible sedan	20.00 ea
AH-313	1930-31 Cabriolet (68-B)	17.50 ea
AH-314	1930-31 Closed pickup cab	10.00 ea

Typical 1926-31 Coupe, Tudor & Pickup Window Parts

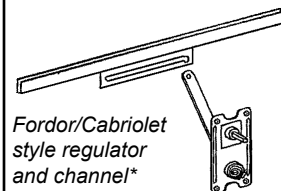

Fordor/Cabriolet style regulator and channel*

Felt Kits

Includes window run felt channels for 2 windows, both right and left sides. Felt channels have attaching clips installed. Window top seals (sponge style) and adhesive are included.

A-45983-PU	1926-27 Coupe & Tudor, 1928-29 Pickup cab	120.00 ea
A-45983-A	1928-31 Tudor, 1928-29 Coupe, 1930-31 PU	120.00 ea
A-45983-B	1930-31 Coupe	120.00 ea
A-45983-V	1931 Victoria & Fordor front doors	120.00 ea
A-56786	1928-31 Tudor quarter windows	60.00 ea
A-45983-4D	1928-30 Fordor front doors	120.00 ea
A-56791-A	1928-30 Fordor rear doors	80.00 ea

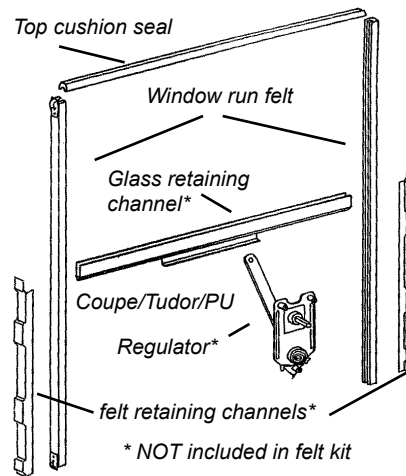

* NOT included in felt kit

Window Glass Top Cushion Only

Sponge style top cushion is included in window felt kits as needed.

1926-27:

T-8399-T	Cushion, fits in retainer	7.50 ea
T-8399-TR	Retainer, steel	40.00 ea

1928-33

A-45983-T	Sponge style, glue in	5.00 ea
-----------	-----------------------	---------

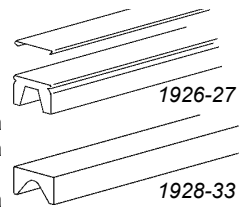

Regulators and Glass Channel: Coupe, Tudor and Pickup

A-48105-A	Regulator: RH Door and Quarter	32.50 ea
A-48106-A	Regulator: LH Door and Quarter	32.50 ea
A-45962-PU	Channel: 1926-27 Coupe & Tudor, 1928-29 PU Doors	27.50 ea
A-45962-S	Channel: 1928-31 Coupe & Tudor, 1930-31 PU Doors	25.00 ea
A-56787	Channel: 1928-31 Tudor Quarter	25.00 ea
B-47106	Channel: 1931 Coupe back window	10.00 ea

Regulators and Glass Channel: 1928-30 Fordor & Cabriolet

A-48105-B	Regulator: RH front door, LH rear door	50.00 ea
A-48106-B	Regulator: LH front door, RH rear door	50.00 ea
A-45963-A	Channel: RH front door, LH rear door	10.00 ea
A-45963-B	Channel: LH front door, RH rear door	10.00 ea

Felt Retainer Channels, Coupe, Tudor and Pickup

	RH Front		LH Front	
1928-29 Cpe/Tudor	A-45970-A	15.00 ea	A-45971-A	15.00 ea
1930-31 Tudor/PU	A-45970-B	15.00 ea	A-45970-B	15.00 ea
1930-31 Coupes	A-45970-C	15.00 ea	A-45971-C	15.00 ea
	RH Back		LH Back	
1928-29 Cpe/Tudor	A-45970-A	15.00 ea	A-45971-A	15.00 ea
1930-31 Tudor/PU	A-45972-B	15.00 ea	A-45973-B	15.00 ea
1930-31 Coupe	A-45972-C	15.00 ea	A-45973-C	15.00 ea

Felt Retainer Channels: 1928-30 Fordor

A-45970-DF	Front door, front or back, 1929-30 Fordor	20.00 ea
A-45970-DR	Rear door, front or back, 1929-30 Fordor	17.50 ea

Window Regulator Repair Kits

Includes pinion gear, handle shaft, housing, clutch mechanism and spring, and 3 housing rivets. Ford had many suppliers, These kits only work when pinion housing mounts with 3 small rivets before ordering.

A-48105-ARK	1928-31 w/5 tooth pinion	30.00 ea
A-48105-BRK	1928-31 w/6 tooth pinion	12.50 ea

* Parts with price listed as "not.avbl" are not known to be available at this time, but are listed for reference.

1926-31 Window Parts, cont

Typical 1930-31 Victoria and 1931 Fordor Window Parts

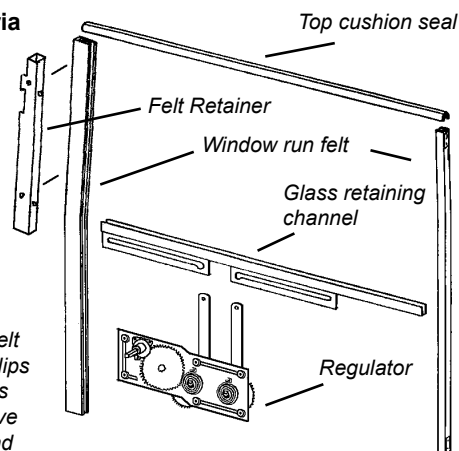

Felt Kits

Includes window run felt channels for 2 windows, both right and left sides. Felt channels have attaching clips installed. Window top seals (sponge style) and adhesive are included. Regulator and glass retaining channels not included.

A-45983-V	1931 Victoria & Fordor front doors	120.00 ea
B-56786-V	1930-31 Victoria quarter windows	95.00 ea
A-56791-B	1931 Fordor rear door & quarter	85.00 ea

Felt Retainer

Used on front doors, retains felt and garnish molding attaches to this.

A-45985-R	RH, Victoria, Fordor front door, and A-400	150.00 ea
A-45985-L	LH, Victoria, Fordor front door, and A-400	150.00 ea

Window Glass Bottom Retaining Channels

B-45962	Door, RH or LH front: 1931 Fordor	40.00 ea
B-55962	Door, RH front: 1930-31 Victoria	45.00 ea
B-55963	Door, LH front: 1930-31 Victoria	45.00 ea
B-56789	Rear door, RH: 1931-34 Fordor	40.00 ea
B-56790	Rear door, LH: 1931-34 Fordor	40.00 ea
A-45963-A	Quarter RH: 1930-32 Victoria, 1931-33 Fordor	10.00 ea
A-45963-B	Quarter LH: 1930-32 Victoria, 1931-33 Fordor	10.00 ea

Window Glass to Setting Channel with Body Seal

Fordor sedan, Victoria, & Cabriolet

Sets glass into channel. When window is rolled up it is sealed to door or body. 6' length.

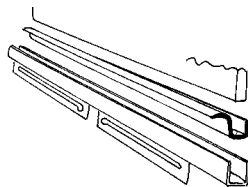

B-45968	10.00 ea
---------	----------

Coupe Rolldown Back Window

A-46108	Window felt kit: 1931 Coupe back window	55.00 ea
B-47106	Glass Channel: 1931 Coupe back window	10.00 ea

Window Glass to Frame Setting Tape

B-37193-A	all years, 20 ft, 1/32" thick	10.00 ea
B-37193-B	all years, 20 ft, 3/64" thick	10.00 ea
B-37193-C	all years, 20 ft, 1/16" thick	15.00 ea
B-37193-D	all years, 20 ft, 5/64" thick	15.00 ea

Fixed Quarter & Back Window Glass Rubber Channels

1926-36 Coupe & Sedan

B-704220	10'	15.00 ea
----------	-----	----------

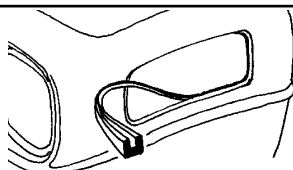

* Parts with price listed as "not.avbl" are not known to be available at this time, but are listed for reference.