

1928-31 Bumpers

1928-31 Bumper Face Bars

Full width bars were used on front, can be used on rear. Clamps and end hardware shown are not included with bumper face bars.

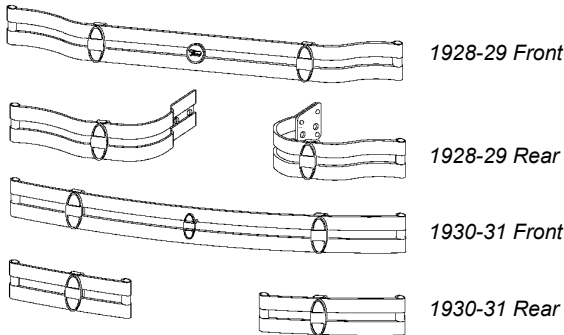

Full Width Face Bars

| | | |
|-------------|-----------------------------------|------------|
| A-17757-CSS | 1928-29, With end eyes, stainless | 400.00 set |
| A-17757-DSS | 1930-31, 61" wide, stainless | 400.00 set |

Rear Bumper Bar Sets

| | | |
|-------------|--------------------|------------|
| A-17784-CSS | 1928-29, Stainless | 400.00 set |
| A-17784-DSS | 1930-31, Stainless | 375.00 set |

1926-31 Bumper Clamps and End Bolts:

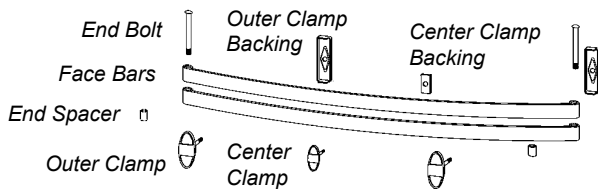

Outer Bumper Clamps

| | | |
|------------|-----------------------------------|----------|
| T-17758 | 1926-27 Outer clamp, black | 12.50 ea |
| T-17758-C | 1926-27 Outer clamp, chrome | 15.00 ea |
| A-17758-CF | 1928-30 Clamp, steel, chrome | 27.50 ea |
| A-17758-DF | 1930-31 Clamp, steel w/stls cover | 12.50 ea |

Outer Bumper Clamp Backing Plates

| | | |
|-----------|-------------------------|---------|
| A-17756-B | 1929-31, Stamped, plain | 7.50 ea |
|-----------|-------------------------|---------|

Center Bumper Clamps

Steel with stainless cover; includes backing plate.

| | | |
|-----------|--------------------------------|----------|
| A-17762-A | 1927 Round, "Ford made in USA" | 12.50 ea |
| A-17762-B | 1927-28 Round, "Ford" | 12.50 ea |
| A-17762-C | 1928-31 Oval, no script | 10.00 ea |

Bumper End Bolts & Spacers

| | | |
|-----------|-----------------------|----------|
| A-17834 | End bolt, plain | 7.50 ea |
| A-17834-C | End bolt, stainless | 12.50 pr |
| A-17759 | End spacer, plain | 2.50 pr |
| A-17759-C | End spacer, stainless | 5.00 ea |

Front Bumper Brackets



| | | |
|--------------|---|-----------|
| A-17754-AS | 1928-29, stock style, plain | 90.00 pr |
| A-17754-BS | 1930-31, stock style, plain | 95.00 pr |
| A-17754-SS | 1930-31, stock style, stainless | 325.00 pr |
| | can be used on 1928-29, moves bumper back | |
| A-17754-SS32 | 1928-31, uses 1932 bumper, stainless | not.avbl |

1928-29 Bumper Brackets to Frame Bolts

| | | |
|--------------|-----------|-----------|
| A-17754-SKSS | Stainless | 15.00 set |
|--------------|-----------|-----------|

1930-31 Front Bumper Bracket & Splash Apron Studs

Set of 4 special studs that mount the front bumper brackets and space the front splash apron from the frame.

| | | |
|------------|-------|-----------|
| A-16527-AS | studs | 25.00 set |
|------------|-------|-----------|

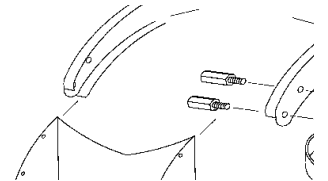

Rear Bumper Bracket Parts:

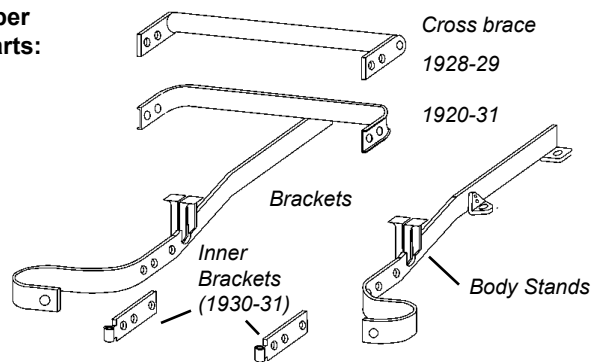

Rear Bumper Brackets: (with body stands)

| | | |
|------------|--|-----------|
| A-17777-CR | 1928-31 Coupe & Roadster | 250.00 pr |
| A-17777-AS | 1928-29 Sedans, 1928-31 4-Door Phaeton | 250.00 pr |
| A-17777-BS | 1930-31 Tudor sedan | 250.00 pr |

Rear Inner Brackets: (used on 1930-31 only)

| | | |
|-----------|---|----------|
| A-17777-I | 1930-31 Coupe, Roadster, Sedan, Phaeton | 25.00 ea |
|-----------|---|----------|

Bumper Cross Members:

| | | |
|------------|------------------------------------|-----------|
| A-17783-A | 1928-30 Rear cross tube, plain | 95.00 ea |
| A-17783-AS | 1928-31 Rear cross tube, stainless | 185.00 ea |
| A-17783-B | 1930-31 Rear cross 1/2 round bar | 55.00 ea |

Rear Bumper Bracket to Body Stands only

| | | |
|------------|-----------------------------------|----------|
| A-17778-B5 | 1928-31 Coupe & Roadster, 5" tall | 25.00 ea |
| A-17778-B4 | 1930-31 Sedan, 4.5" tall | 25.00 ea |
| A-17778-B3 | 1928-29 Sedan, 3" tall | 25.00 ea |

Model A Luggage Rack

Stamped steel, chrome plated with wood trim and mounting brackets.



| | | |
|---------|--|-----------|
| A-18575 | | 130.00 ea |
|---------|--|-----------|

* Parts with price listed as "not.avbl" are not known to be available at this time, but are listed for reference.

1932-36 Bumpers

1932 Bumper and Bolts

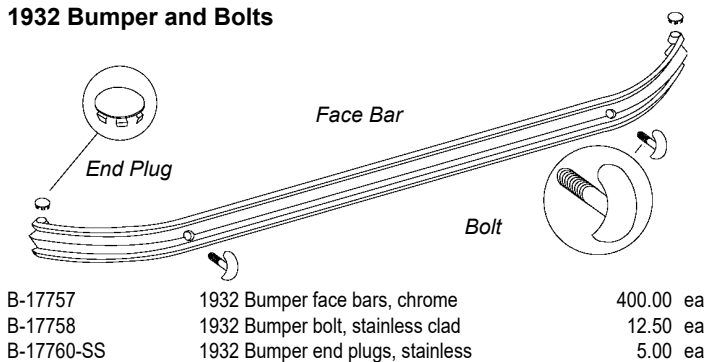

| | | |
|------------|----------------------------------|-----------|
| B-17757 | 1932 Bumper face bars, chrome | 400.00 ea |
| B-17758 | 1932 Bumper bolt, stainless clad | 12.50 ea |
| B-17760-SS | 1932 Bumper end plugs, stainless | 5.00 ea |

1933-36 Bumper Face Bars

Passenger and Pickup bumpers of the same year are interchangeable

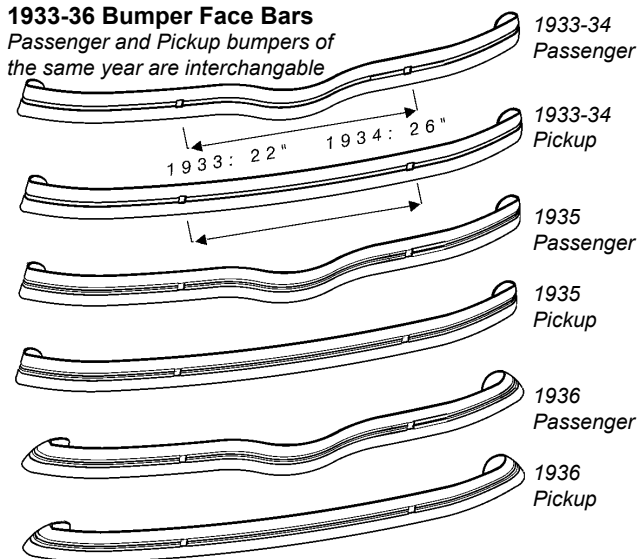

| | Chrome | | Stainless | |
|--------------------|------------|-----------|-------------|-----------|
| 1933 Passenger | 40-17757-A | 400.00 ea | 40-17757-AS | 525.00 ea |
| 1933 Pickup | 46-17757-A | 450.00 ea | 46-17757-AS | 525.00 ea |
| 1934 Passenger | 40-17757-B | 400.00 ea | 40-17757-BS | 525.00 ea |
| 1934 Victoria Rear | 40-17757-V | 525.00 ea | | |
| 1934 Pickup | 46-17757-B | 450.00 ea | 46-17757-BS | 525.00 ea |
| 1935 Passenger | 48-17757 | 450.00 ea | 48-17757-S | 525.00 ea |
| 1935 Pickup | 50-17757 | 450.00 ea | 50-17757-S | 525.00 ea |
| 1936 Passenger | 68-17757 | 450.00 ea | 68-17757-S | 525.00 ea |
| 1936 Pickup | 67-17757 | 450.00 ea | 67-17757-S | 525.00 ea |

Bumper Bolts

| | | |
|-----------|------------------------------|---------|
| 40-17758 | Oval, bumper face, stainless | 7.50 ea |
| B-42034-P | Round, bumper end, plain | 0.50 ea |
| B-42034-S | Round, bumper stainless clad | 0.75 ea |

1932-36 Front Bumper Brackets

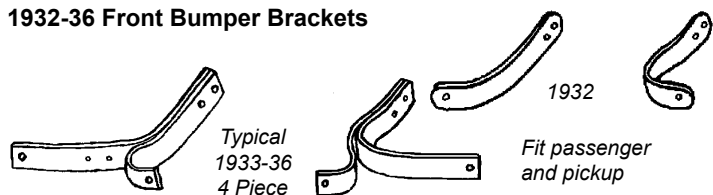

| | Mild Steel | | Stainless | |
|--------------|-------------|------------|--------------|------------|
| 1932 Stock | B-17754-S | 110.00 pr | B-17754-SS | 325.00 pr |
| 1932 Shortie | B-17754-SH | not.avbl | B-17754-SSH | not.avbl |
| 1933 | 40-17754-AS | 175.00 set | 40-17754-ASS | 475.00 set |
| 1934 | 40-17754-BS | 175.00 set | 40-17754-BSS | 475.00 ea |
| 1935 | 48-17754-S | 175.00 set | 48-17754-SS | 475.00 set |
| 1936 | 68-17754-S | 175.00 set | 68-17754-SS | 475.00 set |

1932 Front Bumper Bracket Mount Kit

Includes special studs to offset splash apron from frame. Bolts and studs mount bumper brackets and front spreader bar to frame

| | | |
|-----------|---------------------------|-----------|
| B-16525-S | 1932 Passenger and Pickup | 25.00 set |
|-----------|---------------------------|-----------|

1932-36 Rear Bumper Bracket Sets

Ford did not supply rear bumpers for 1932-35 Pickups

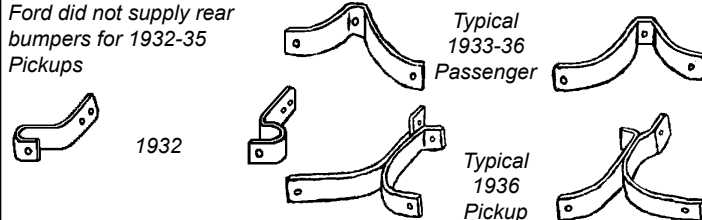

| | Mild Steel | | Stainless | |
|----------------------|-------------|------------|--------------|-----------|
| 1932 Passenger Stock | B-17314-AS | 110.00 pr | B-17314-SS | 325.00 pr |
| 1932 Pass Shortie | B-17314-ASH | 170.00 pr | B-17314-SSH | 325.00 pr |
| 1933 Pass, Stock | 40-17314-AS | 110.00 pr | | |
| 1933 Pass, Shorty | 40-17314-AH | 170.00 pr | 40-17314-AHS | 325.00 pr |
| 1934 Pass, Stock | 40-17314-BS | 110.00 pr | | |
| 1934 Pass, Shorty | 40-17314-BH | 170.00 pr | 40-17314-BHS | 325.00 pr |
| 1934 Victoria | 40-17314-VS | 150.00 pr | | |
| 1935 Pass Stock | 48-17314-S | 110.00 pr | | |
| 1936 Pass Stock | 68-17314-S | 110.00 pr | | |
| 1935-36 Pass Shorty | 48-17314-H | 170.00 pr | 48-17314-HS | 325.00 pr |
| 1935-36 Pickup | 67-17314-S | 175.00 set | | |

Front License Plate Bracket

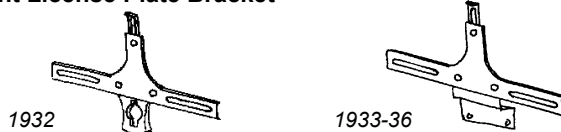

| | Stainless | | Black | |
|---------|-----------|----------|-----------|----------|
| 1932 | B-5034-B | 30.00 ea | B-5034-C | 30.00 ea |
| 1933-36 | 40-5034-B | 22.50 ea | 40-5034-C | 27.50 ea |

Bumper Guards

1933-34 All models:

| | |
|----------|----------|
| 40-17996 | 50.00 ea |
|----------|----------|

1933-34 bumper guard bolts

| | |
|------------|---------|
| 40-17758-R | 7.50 ea |
|------------|---------|

1935 All models:

| | |
|----------|----------|
| 48-17996 | 60.00 ea |
|----------|----------|

1936 All models:

| | |
|----------|----------|
| 68-17996 | not.avbl |
|----------|----------|

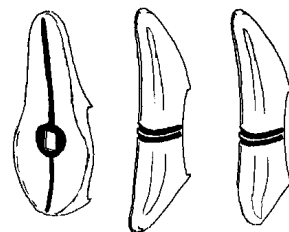

1935-36 Front Bumper Arm Grommets

1935 Passenger & Commercial:

(hole in fender for bumper arm)

| | |
|------------|----------|
| 48-17772-S | 25.00 pr |
|------------|----------|

1936-37 Commercial:

(notch in fender for bumper arm)

| | |
|------------|----------|
| 50-17772/3 | 25.00 pr |
|------------|----------|

1936-37 Passenger:

| | |
|------------|----------|
| 68-17772/3 | 25.00 pr |
|------------|----------|



1934 Victoria Rear Bumper Arm Grommets

| | | |
|------------|-----------------------|----------|
| 40-17792-V | 1934 Victoria, rubber | 35.00 pr |
|------------|-----------------------|----------|

* Parts with price listed as "not.avbl" are not known to be available at this time, but are listed for reference.

1937-40 Passenger, 1937-41 Pickup Bumpers

Bumper Face Bars

1937-38 & 1939 Std & Pickup

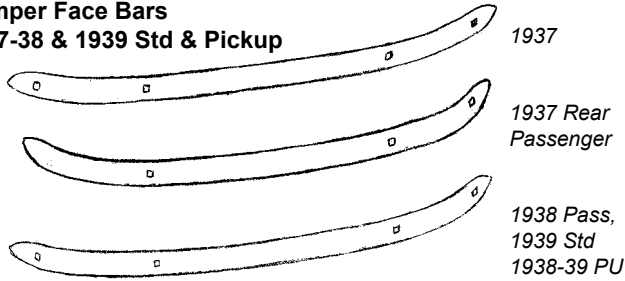

| | Chrome | | Stainless | |
|------------------------|------------|-----------|-------------|-----------|
| 1937 Front (& PU rear) | 78-17757-A | 450.00 ea | 78-17757-AS | 525.00 ea |
| 1937 Pass Rear | 78-17757-B | 450.00 ea | 78-17757-BS | 525.00 ea |
| 1938 Pass, 1939 Std | 81A-17757 | 450.00 ea | 81A-17757-S | 525.00 ea |
| 1938-39 Pickup | | | | |

Bumper Face Bars

1939 Deluxe, 1940 Passenger, 1940-41 Pickup

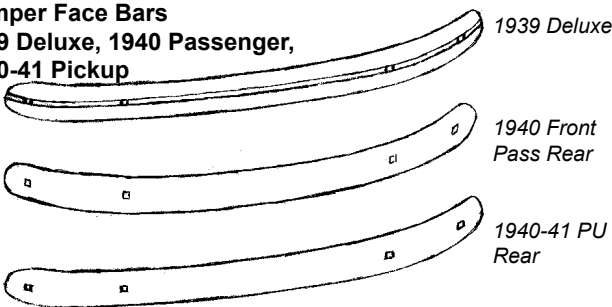

Chrome bumper face bars have stock mounting holes. Smooth stainless face bars have studs welded and do not have exposed bolt heads.

| | Chrome | | Smooth Stainless | |
|----------------------|-----------|-----------|------------------|-----------|
| 1939 Deluxe | 91A-17757 | 450.00 ea | 91A-17757-HR | 575.00 ea |
| 1940 Passenger | 01A-17757 | 400.00 ea | 01A-17757-HR | 575.00 ea |
| 1940-41 Pickup Front | 01A-17757 | 400.00 ea | 01A-17757-HR | 575.00 ea |
| 1940-41 PU Rear | 01C-17757 | 450.00 ea | 01C-17757-HR | 525.00 ea |

Bumper Guards, Chrome Plated

| | |
|-----------------------|----------|
| 1937 All models | not.avbl |
| 1939 Deluxe passenger | not.avbl |
| 91A-17996 | 60.00 ea |
| 1940 All models | not.avbl |
| 01A-17996 | 50.00 ea |

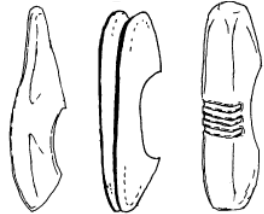

1940 Grille Guard

Ford script, steel, chrome plated

| | |
|-----------|-----------|
| 01A-17799 | 350.00 ea |
|-----------|-----------|

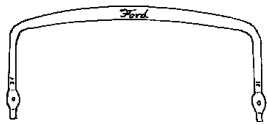

Bumper Face Bolts

Oval Head

Stainless, fine thread

1933-40 Oval Head

| | | |
|----------|-------------|---------|
| 40-17758 | 1 1/4" long | 7.50 ea |
|----------|-------------|---------|

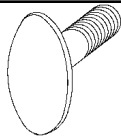

Front License Plate Brackets

1937-38 Pass & 1939 Std, 1937-39 Pickup:

| | | |
|-----------|-----------|----------|
| 78-5034-B | Black | not.avbl |
| 78-5034-C | Stainless | 45.00 ea |

1939 Deluxe, All 1940, 1940-41 Pickup:

| | | |
|------------|-----------|----------|
| 91A-5034-B | Black | 22.50 ea |
| 91A-5034-C | Stainless | 27.50 ea |

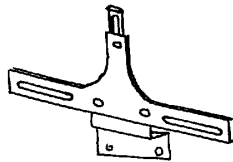

Front Bumper

Brackets (Set of 4)

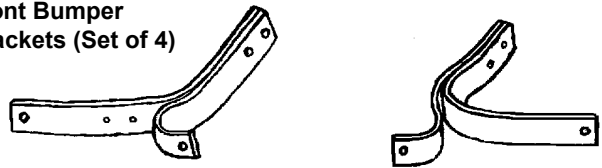

| | Plain | | Stainless | |
|---------------------|-------------|------------|--------------|------------|
| 1937 | 78-17754-S | 175.00 set | 78-17754-SS | 475.00 set |
| 1938 Pass, 1939 Std | 81A-17754-S | 175.00 set | 81A-17754-SS | not.avbl |
| 1938-39 Pickup | | | | |
| 1939 Deluxe | 91A-17754-S | 175.00 set | | |
| 1940 Pass, 40-41 PU | 01A-17754-S | 175.00 set | 01A-17754-SS | 475.00 ea |

Front Bumper Arm Grommets, rubber

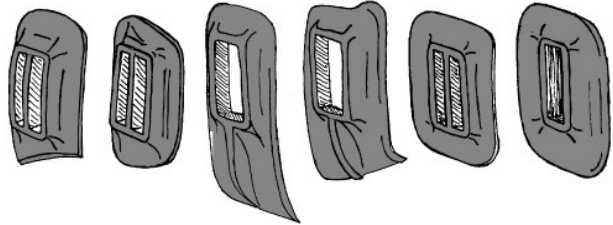

| | | |
|-------------|---|----------|
| 68-17772/3 | 1936-37 Passenger, 1938 Standard | 25.00 pr |
| 81A-17772/3 | 1938 Deluxe, 1939 Standard | 25.00 pr |
| 81C-17772/3 | 1938-39 Commercial | 25.00 pr |
| 99A-17772-S | 1939-40 Mercury | 42.50 pr |
| 01A-17772/3 | 1939-40 Deluxe, 1940 Std, 1940-41 1/2 Ton | 25.00 pr |

Rear Bumper

Brackets (set of 4)



| | Plain | | Stainless | |
|---------------------|-------------|------------|--------------|------------|
| 1937 Passenger | 78-17314-S | 175.00 set | 78-17314-SS | 475.00 set |
| 1937 Pickup | 77-17314-S | 175.00 set | | |
| 1938 Pass, 1939 Std | 81A-17314-S | 175.00 set | 81A-17314-SS | not.avbl |
| 1938-41 Pickup | 81C-17314-S | 175.00 set | | |
| 1939 Deluxe | 91A-17314-S | 175.00 set | | |
| 1940 Passenger | 01A-17314-S | 175.00 set | 01A-17314-SS | 475.00 ea |

Rear Bumper Arm Grommets, rubber

1937-40 Coupe Convertible,

1937 Sedans and Phaeton,

1938 Standard Sedans:

| | |
|------------|----------|
| 78-17792/3 | 25.00 pr |
|------------|----------|

1938 Deluxe Sedan

1939-40 Sedan:

| | |
|-------------|----------|
| 81A-17792/3 | 25.00 pr |
|-------------|----------|

1940-41 Sedan Delivery:

| | |
|-----------|----------|
| 01A-17792 | 40.00 pr |
|-----------|----------|

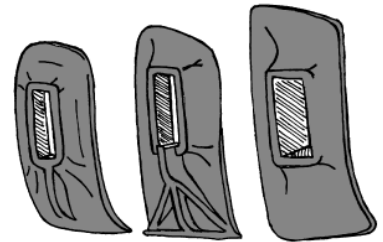

Rear Bumper Splash & Rock Guards

Mounts to bumper bracket and helps deflect rocks and splash from coming up onto rear deck.



| | | |
|--------|----------------------------|-----------|
| BSA40P | 1940 Passenger: fiberglass | 200.00 ea |
|--------|----------------------------|-----------|

* Parts with price listed as "not.avbl" are not known to be available at this time, but are listed for reference.

1941-48 Passenger Bumpers

1941 Passenger Bumper Arm Grommets

| | | |
|-------------|-------|----------|
| 11A-17772/3 | Front | 25.00 pr |
| 11A-17792/3 | Rear | 25.00 pr |

1942-48 Front Bumper Bracket to Bumper

Apron Bumpers, rubber

| | | |
|-------------|----------|-----------|
| 21A-17749-B | Set of 4 | 20.00 set |
|-------------|----------|-----------|

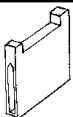

1946-48 Rear Bumper Splash Guards

Mounts to bumper bracket and helps deflect rocks and splash from coming up onto rear deck.

| | | |
|----------|----------------------------------|-----------|
| 6A-17808 | Splash guard, Stamped Steel | 275.00 ea |
| 6A-17832 | Splash guard to body rubber seal | 20.00 ea |

Bumper Face Bolts

Stainless clad, fine thread

1941-48 Square Head

| | | |
|-----------|-------------|----------|
| 11A-17758 | 1 1/4" long | 10.00 ea |
| 11A-17908 | 2 1/2" long | 17.50 ea |
| 21A-17908 | angled | not.avbl |

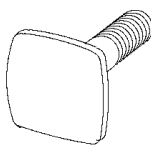

1932-47 Truck 1942-47 Pickup Bumpers

Bumper Face Bar

| | | |
|--------------|---------------------------------------|-----------|
| 21C-17757-S | Stainless: w/holes for bolts | 575.00 ea |
| 21C-17757-HR | Stainless, smoothie, with mount studs | 575.00 ea |

Bumper Bolt

| | | |
|-------------|-----------|---------|
| BB-17758-SS | Stainless | 7.50 ea |
|-------------|-----------|---------|

1948-56 Pickup Bumpers

Front Bumpers

1948-52 Smooth face, plain (with brackets):

| | |
|---|-----------|
| 7C-17750-A | 150.00 ea |
| 1948-52 Smooth face, Stainless (w/bkts) | |
| 7C-17750-SS | 375.00 ea |

1951-52 Ribbed face, Chrome, (no brackets)

| | |
|------------|-----------|
| 1C-17750-A | 250.00 ea |
|------------|-----------|

1948-52 Brackets, Stainless

| | |
|-------------|----------|
| 7C-17754-SS | 70.00 pr |
|-------------|----------|

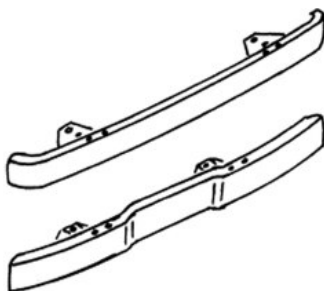

1953-56 Plain

| | |
|--------------|-----------|
| BAAA-17750-B | 150.00 ea |
|--------------|-----------|

1953-56 Stainless:

| | |
|---------------|-----------|
| BAAA-17750-SS | 375.00 ea |
|---------------|-----------|

Rear Bumpers, 1948-56

1948-56 Smooth Face, Plain

| | |
|--------------|-----------|
| BAAA-17906-A | 150.00 ea |
|--------------|-----------|

1951-52 Ribbed Face, Chrome

| | |
|------------|-----------|
| 1C-17906-B | 250.00 ea |
|------------|-----------|

1948-56 Smooth Face, Stainless

| | |
|---------------|-----------|
| BAAA-17906-SS | 375.00 ea |
|---------------|-----------|

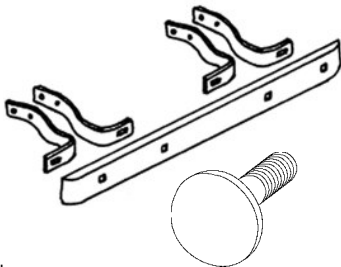

Rear Bumper Brackets

2 left and 2 right brackets are needed for rear bumper.

| | | |
|-------------|----------------------------------|------------|
| B5C-17787-S | Rear bumper bkts, 4pc set, 48-56 | 135.00 set |
|-------------|----------------------------------|------------|

Rear Bumper Face Bolts

| | | |
|-------------|-----------|---------|
| BB-17758-SS | Stainless | 0.50 ea |
|-------------|-----------|---------|

Custom Bumpers

Classic 5 Rib Style Bumpers

Extruded aluminum and highly polished.
Mounting holes are not drilled, allowing these to fit most years.

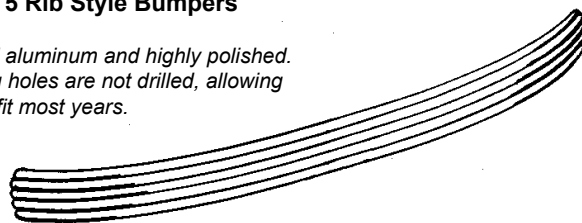

| | | |
|---------------|----------------------------------|-----------|
| HR-17757-D64F | Flat arc w/curved ends, 64" wide | 250.00 ea |
| HR-17757-D64A | 1940 Ford arc, 64" wide | 250.00 ea |
| HR-17757-D66F | Flat arc w/curved ends, 66" wide | 250.00 ea |
| HR-17757-D66A | 1940 Ford arc, 66" wide | 250.00 ea |
| HR-17757-D68F | Flat arc w/curved ends, 68" wide | 250.00 ea |

1949 Chev Style License Plate Guard

For "DeSoto" 5 rib bumpers, aluminum

| | |
|--------------|-----------|
| HR-17757-CLG | 165.00 ea |
|--------------|-----------|

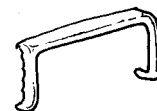

The Custom 3-Rib Style Bumpers

Three-rib style similar to DeSoto style.
Extruded aluminum and highly polished.
These look best on earlier cars such as 1928-34 Fords.

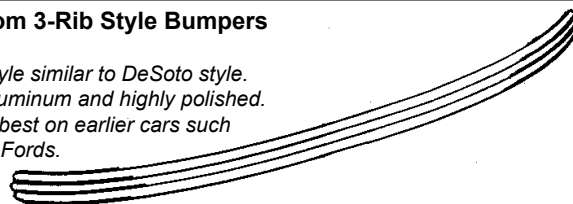

| | | |
|---------------|----------------------------------|-----------|
| HR-17757-R64F | Flat arc w/curved ends, 64" wide | 250.00 ea |
| HR-17757-R64A | 1940 Ford arc, 64" wide | 250.00 ea |
| HR-17757-R66F | Flat arc w/curved ends, 66" wide | 250.00 ea |
| HR-17757-R66A | 1940 Ford arc, 66" wide | 250.00 ea |
| HR-17757-R68F | Flat arc w/curved ends, 68" wide | 250.00 ea |

Bumper Face Bolt for DeSoto or 3-Rib Bumper

| | | |
|-------------|-----------------|----------|
| HR-17758-DS | stainless steel | 12.50 ea |
|-------------|-----------------|----------|

* Parts with price listed as "not.avbl" are not known to be available at this time, but are listed for reference.